

A BRIEF HISTORY OF THE  
UNITED STATES PATENT SYSTEM



GREEK CULINARY OFFERING



TIBERIUS CAESAR



FILIPPO BRUNELLESCHI

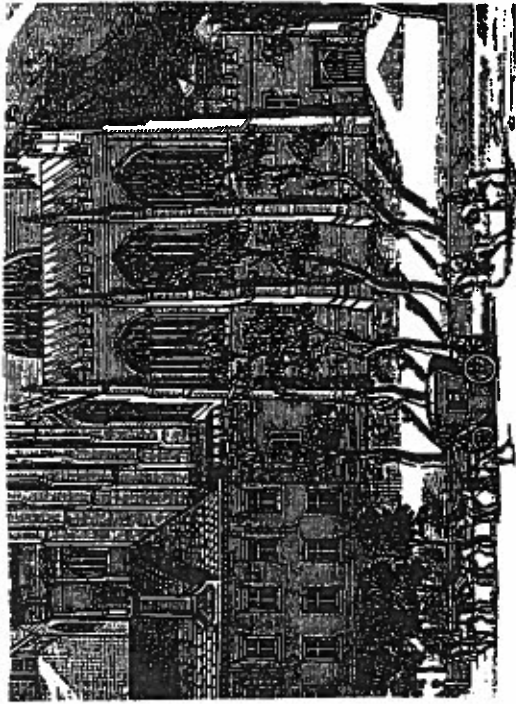

CHAPEL AT ETON COLLEGE

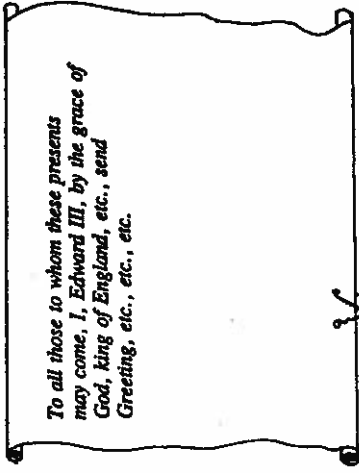

*To all those to whom these presents  
may come, I, Edward III, by the grace of  
God, king of England, etc., send  
Greeting, etc., etc., etc.*

Classic Form of  
Letters Patent

Great  
Seal



ELIZABETH I, QUEEN OF ENGLAND

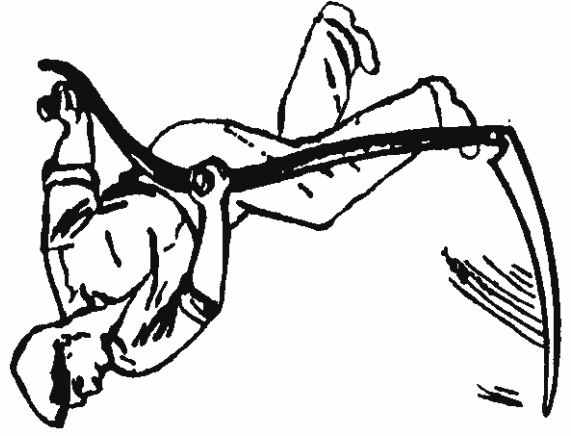

SCYTHE, AFTER JENES' IMPROVEMENT

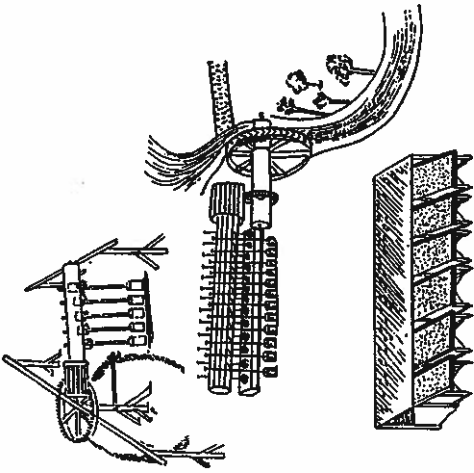

SIBELLA MASTERS' STAMPING MILL

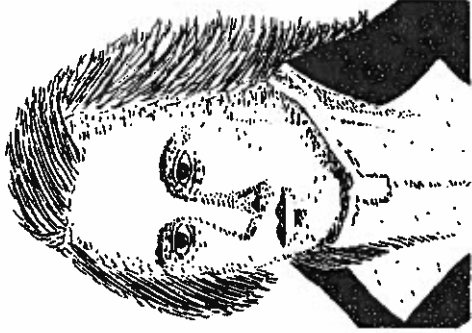

JAMES RUMSEY



JOHN FITCH

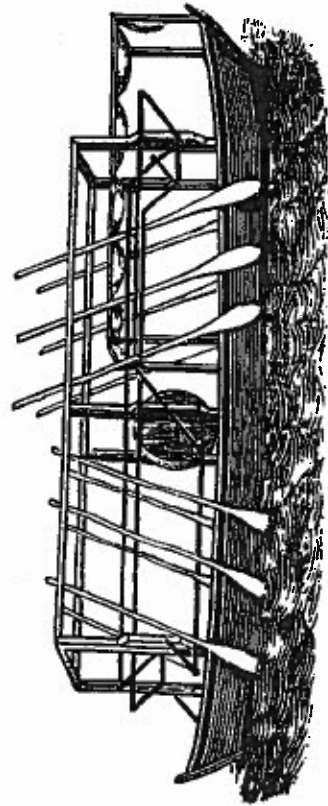

JOHN FITCH'S STEAMBOAT  
AS SHOWN AT CONSTITUTIONAL CONVENTION



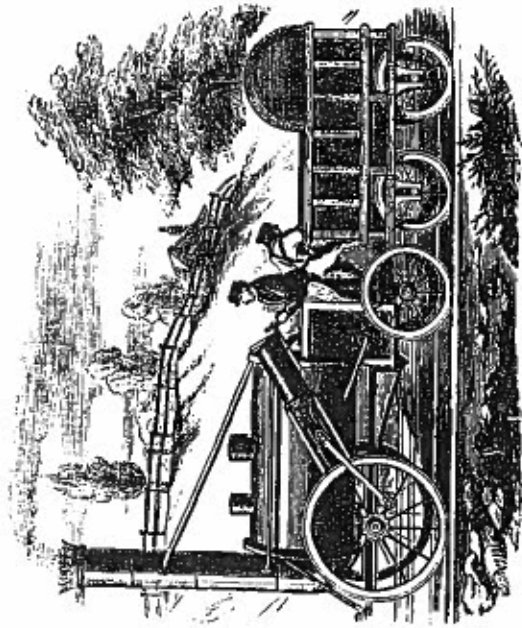

EARLY LOCOMOTIVE ENGINE

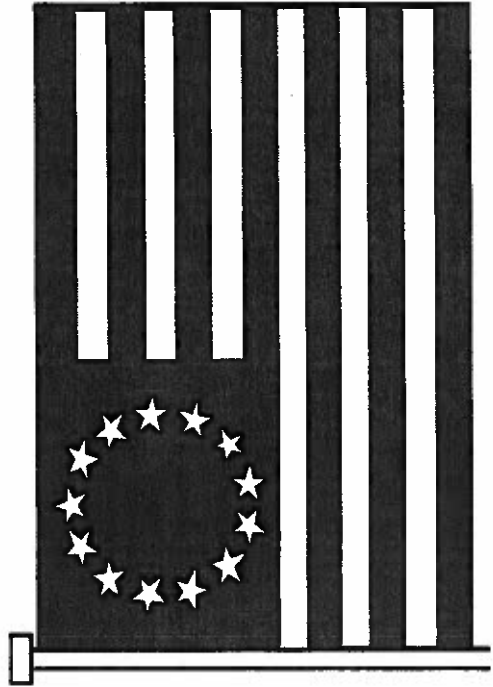
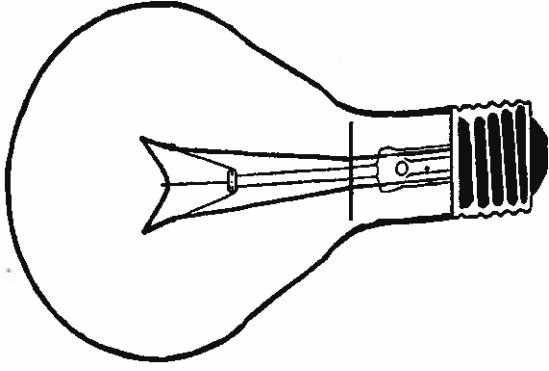

EDMUND RANDOLPH  
ATTORNEY GENERAL



HENRY KNOX  
SECRETARY OF WAR



THOMAS JEFFERSON  
SECRETARY OF STATE

THE PATENT BOARD





DR. WILLIAM THORNTON

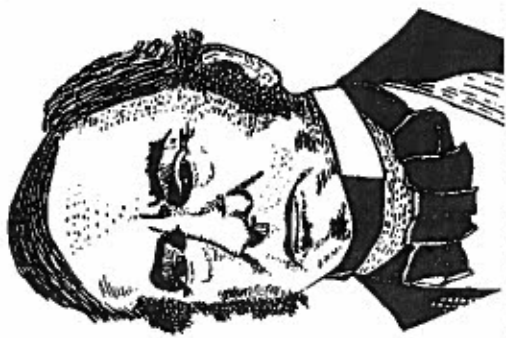

HENRY L. ELLSWORTH

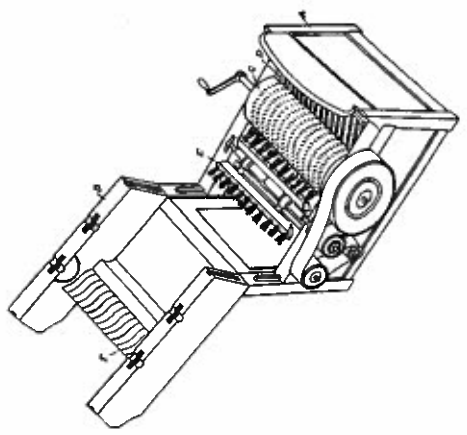

ELI WHITNEY'S COTTON GIN

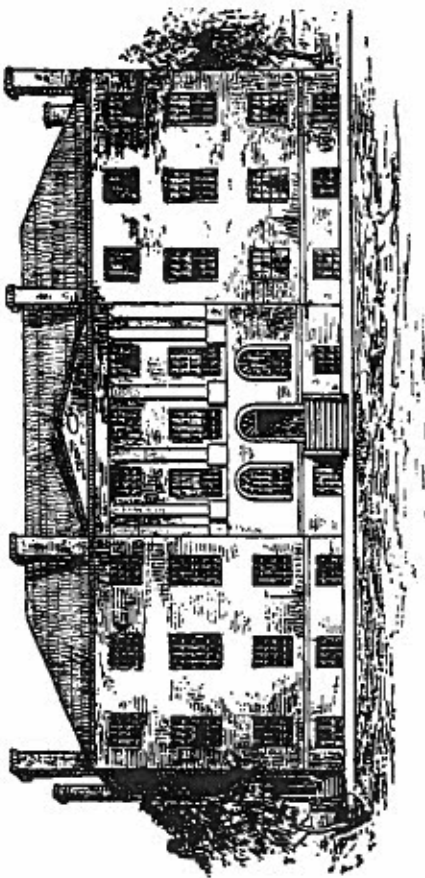

*Blodgett's Hotel*



JOHN RUGGLES

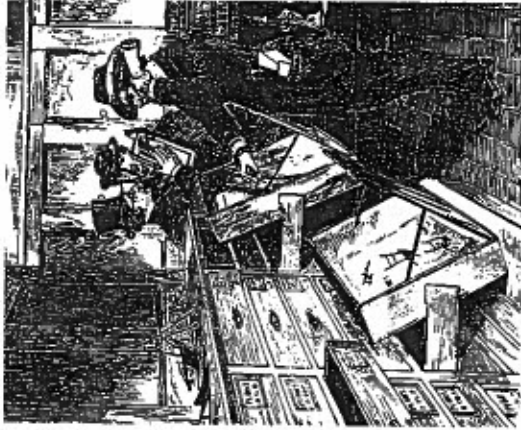

PATENT EXAMINERS AT WORK  
Harper's Weekly, July 10, 1869

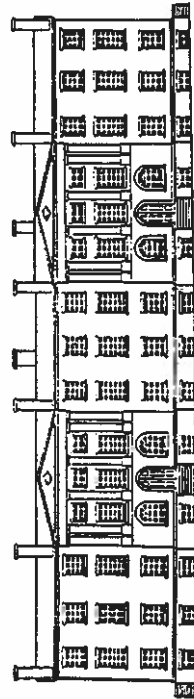

BLODGETT'S HOTEL, BEFORE

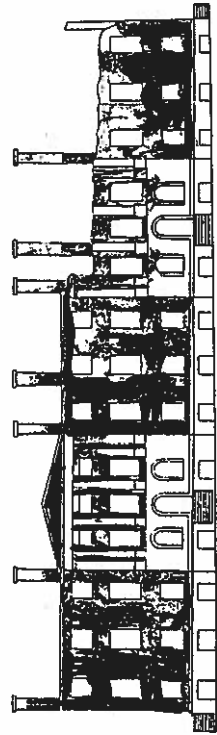

AND AFTER THE FIRE OF DECEMBER 15, 1836

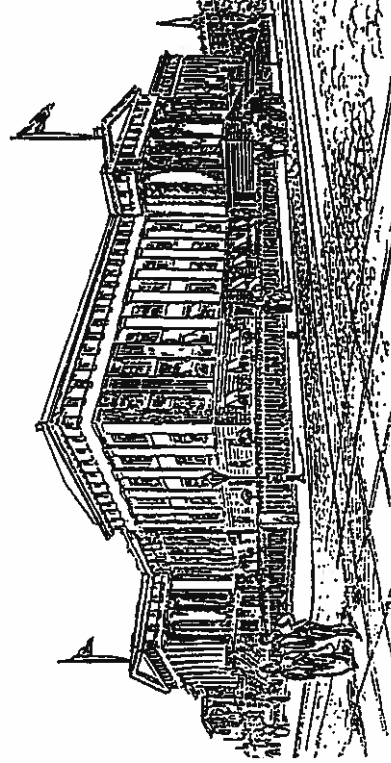

U. S. PATENT OFFICE  
Harper's Weekly, ca 1887



ANNIE ELLSWORTH

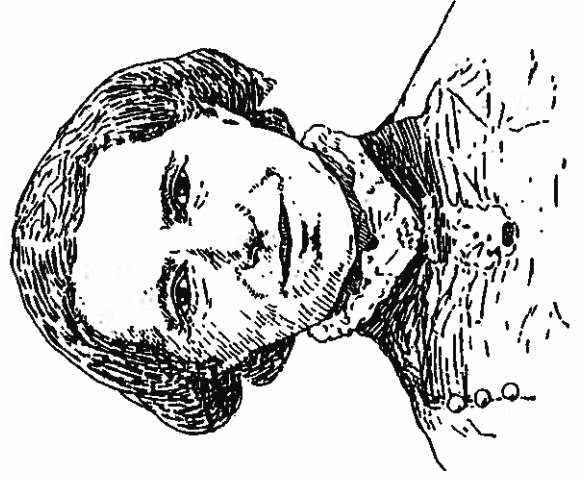

CLARA BARTON



SAMUEL F.B. MORSE

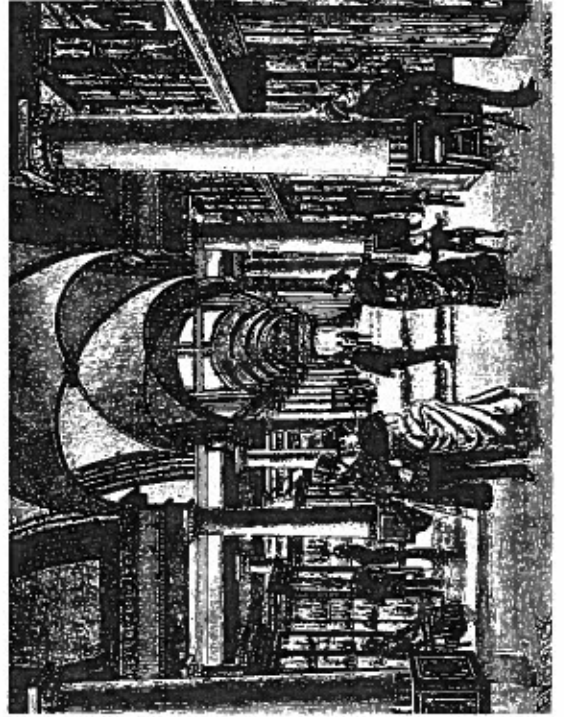

SOUTH HALL, MUSEUM OF MODELS, PATENT OFFICE.

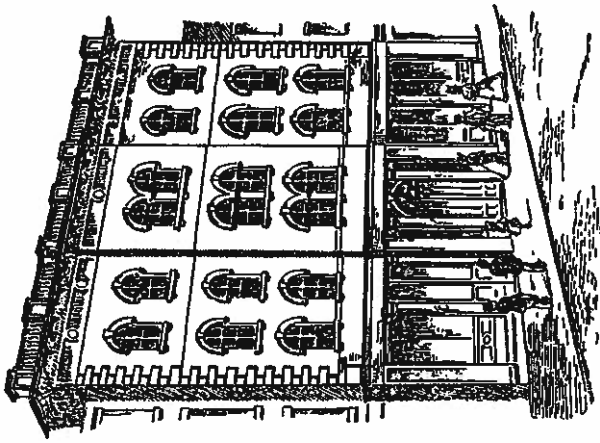

Confederate Patent Office



THOMAS ALLEN JENCKES



DAVID P. HOLLOWAY

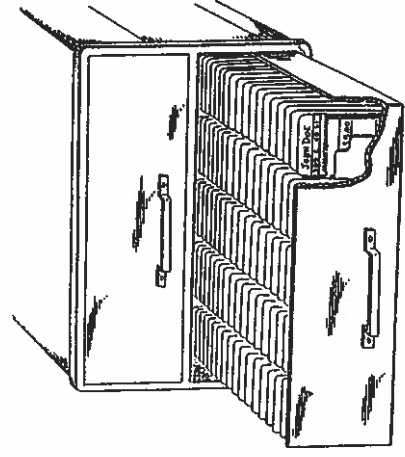

EARLY DEPOSIT ACCOUNT ?



**ORSON D. MUNN**  
PUBLISHERS OF SCIENTIFIC AMERICAN AND FOUNDERS OF MUNN & CO



**ALFRED E. BEACH**  
PUBLISHERS OF SCIENTIFIC AMERICAN AND FOUNDERS OF MUNN & CO



**KOREKIYO TAKAHASHI**

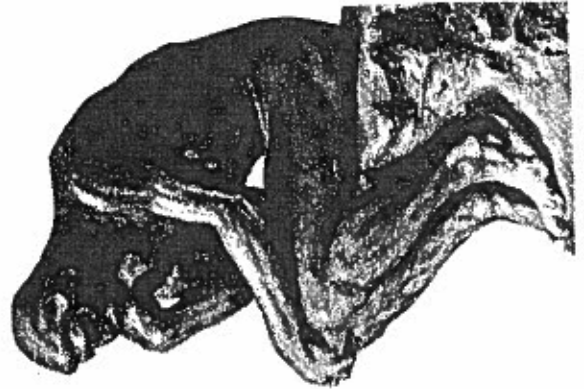

**SOME MEN DREAM  
AND ASK WHY NOT**

The full text of  
**The Patent Office Pony –  
A History of the Early Patent Office**

with other related material  
is available on-line at

<http://myoutbox.net/pohome.htm>

But the book itself is  
out-of-print